

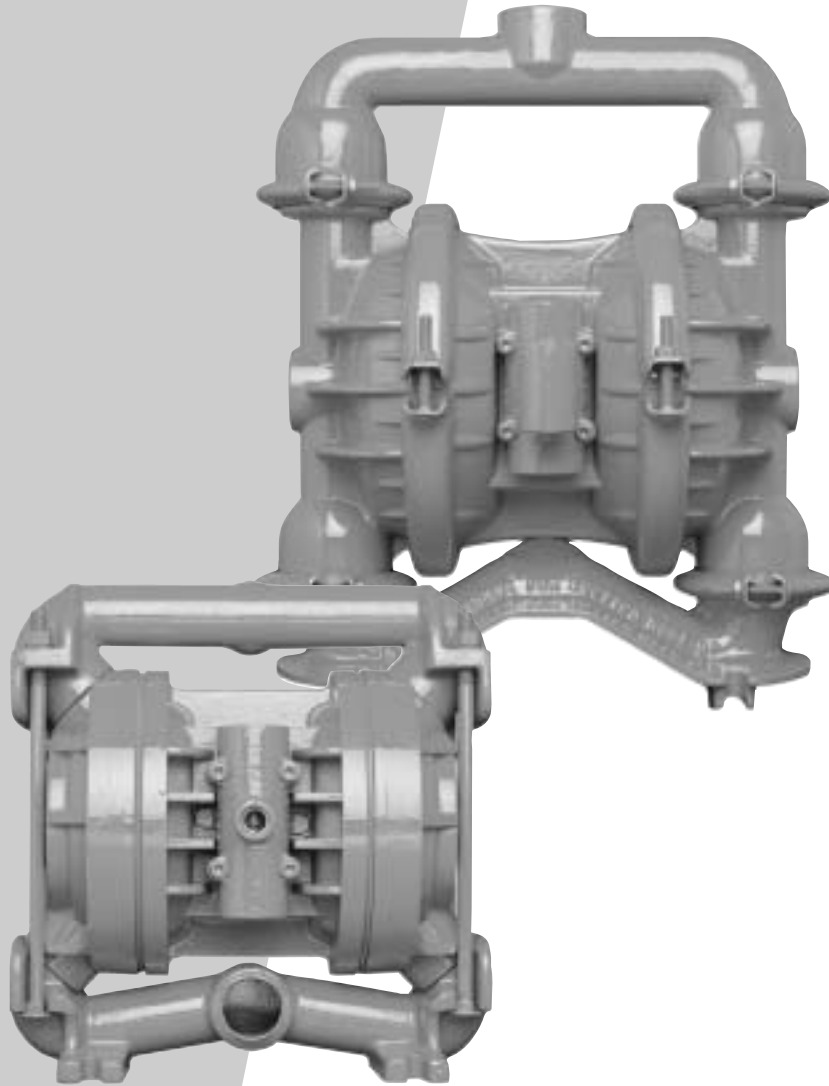

# Pump Owners Manual



 LISTED

84811  
84812  
84813

Series "A"



One Lincoln Way • St. Louis, Missouri 63120-1578  
[www.lincolnindustrial.com](http://www.lincolnindustrial.com)

# TABLE OF CONTENTS

---

	PAGE #
SECTION # 1 — HOW IT WORKS .....	1
SECTION # 2 — CAUTIONS .....	2
SECTION # 3 — DIMENSIONAL DRAWINGS	
A. Model 84811 & 84812 .....	3
B. Model 84813 .....	3
SECTION # 4 — PERFORMANCE CURVES	
A. Model 84811 .....	4
B. Model 84812 .....	4
C. Model 84813 .....	5
SECTION # 5 — SUCTION LIFT CURVES	
A. Model 84811 & 84812 .....	6
B. Model 84813 .....	6
SECTION # 6 — INSTALLATION AND OPERATION	
A. Installation .....	7
B. Operation & Maintenance .....	8
C. Troubleshooting Pumps .....	9
SECTION # 7 — DIRECTIONS FOR DISASSEMBLY/REASSEMBLY	
A. Model 84811 & 84812 .....	10
B. Model 84813 .....	12
C. Reassembly Hints & Tips .....	14
D. Air Valve / Center Section Maintenance .....	15
SECTION # 8 — EXPLODED VIEW/PARTS LISTING	
A. Model 84811 & 84812 .....	16
B. Model 84813 .....	18

# SECTION 1

## HOW IT WORKS

The diaphragm pump is an air-operated, positive displacement, self-priming pump. These drawings show the flow pattern through the pump upon its initial stroke. It is assumed the pump has no fluid in it prior to its initial stroke.

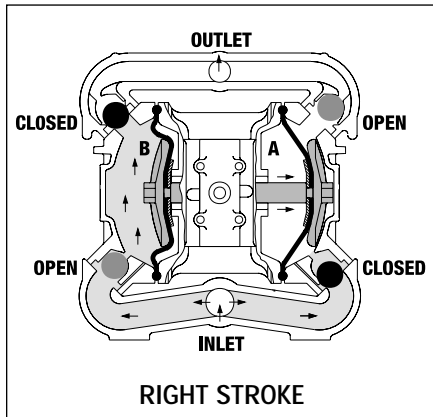

FIGURE 1 The air valve directs pressurized air to the back side of diaphragm A. The compressed air is applied directly to the liquid column separated by elastomeric diaphragms. The diaphragm acts as a separation membrane between the compressed air and liquid, balancing the load and removing mechanical stress from the diaphragm. The compressed air moves the diaphragm away from the center block of the pump. The opposite diaphragm is pulled in by the shaft connected to the pressurized diaphragm. Diaphragm B is on its suction stroke; air behind the diaphragm has been forced out to the atmosphere through the exhaust port of the pump. The movement of diaphragm B toward the center block of the pump creates a vacuum within chamber B. Atmospheric pressure forces fluid into the inlet manifold forcing the inlet valve ball off its seat. Liquid is free to move past the inlet valve ball and fill the liquid chamber (see shaded area).

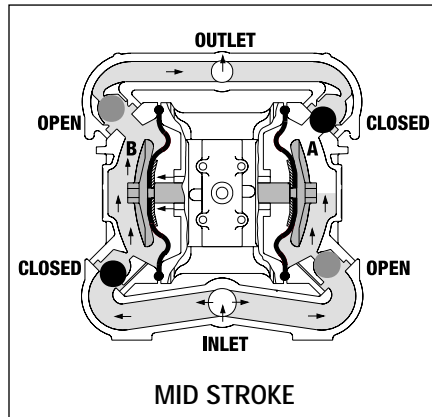

FIGURE 2 When the pressurized diaphragm, diaphragm A, reaches the limit of its discharge stroke, the air valve redirects pressurized air to the back side of diaphragm B. The pressurized air forces diaphragm B away from the center block while pulling diaphragm A to the center block. Diaphragm B is now on its discharge stroke. Diaphragm B forces the inlet valve ball onto its seat due to the hydraulic forces developed in the liquid chamber and manifold of the pump. These same hydraulic forces lift the discharge valve ball off its seat, while the opposite discharge valve ball is forced onto its seat, forcing fluid to flow through the pump discharge. The movement of diaphragm A toward the center block of the pump creates a vacuum within liquid chamber A. Atmospheric pressure forces fluid into the inlet manifold of the pump. The inlet valve ball is forced off its seat allowing the fluid being pumped to fill the liquid chamber.

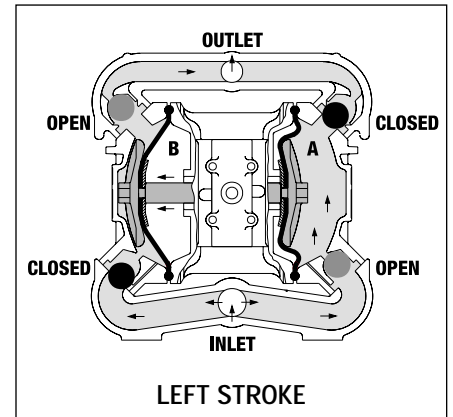

















FIGURE 3 At completion of the stroke, the air valve again redirects air to the back side of diaphragm A, which starts diaphragm B on its exhaust stroke. As the pump reaches its original starting point, each diaphragm has gone through one exhaust and one discharge stroke. This constitutes one complete pumping cycle. The pump may take several cycles to completely prime depending on the conditions of the application.

## SECTION 2

# CAUTIONS – READ FIRST!

-  **TEMPERATURE LIMITS:**  
Buna-N            -12.2°C to 82.2°C    10°F to 180°F  
Teflon® PTFE    4.4°C to 104.4°C    40°F to 220°F
-  **CAUTION:** When choosing pump materials, be sure to check the temperature limits for all wetted components. Example: Teflon® PTFE has a maximum limit of 104.4°C (220°F) but Buna-N has a maximum limit of only 82.2°C (180°F).
-  **CAUTION:** Maximum temperature limits are based upon mechanical stress only. Certain chemicals will significantly reduce maximum safe operating temperatures. Consult engineering guide for chemical compatibility and temperature limits.
-  **CAUTION:** Always wear safety glasses when operating pump. If diaphragm rupture occurs, material being pumped may be forced out air exhaust.
-  **WARNING:** Prevention of static sparking — If static sparking occurs, fire or explosion could result. Pump, valves, and containers must be properly grounded when handling flammable fluids and whenever discharge of static electricity is a hazard.
-  **NOTE:** UL-listed pumps must not exceed 3.4 Bar (50 psig) air supply pressure.
-  **CAUTION:** Before any maintenance or repair is attempted, the compressed air line to the pump should be disconnected and all air pressure allowed to bleed from pump. Disconnect all intake, discharge and air lines. Drain the pump by turning it upside down and allowing any fluid to flow into a suitable container.
-  **CAUTION:** Blow out air line for 10 to 20 seconds before attaching to pump to make sure all pipe line debris is clear. Use an in-line air filter. A 5µ (micron) air filter is recommended.
-  **NOTE:** When installing Teflon® diaphragms, it is important to tighten outer pistons simultaneously (turning in opposite directions) to ensure tight fit.
-  **NOTE:** Tighten clamp bands and retainers prior to installation. Fittings may loosen during transportation.
-  **CAUTION:** Even when air line is disconnected pump may still be under pressure. Use care when bleeding pressure from pump before disassembly.
-  **NOTE:** Before starting disassembly, mark a line from each liquid chamber to its corresponding air chamber. This line will assist in proper alignment during reassembly.
-  **CAUTION:** Verify the chemical compatibility of the process and cleaning fluid.
-  **CAUTION:** When removing the end cap using compressed air, the air valve end cap may come out with considerable force. Hand protection such as a padded glove or rag should be used to capture the end cap.
-  **CAUTION:** Only explosion proof (NEMA 7) solenoid valves should be used in areas where explosion proof equipment is required.

### CAUTION

Make sure air line pressure to pump does not exceed 50 psig. If it does, a pressure regulator should be installed and set at a maximum of 50 psig.

## SECTION 3A

# DIMENSIONAL DRAWING

## MODELS 84811 & 84812

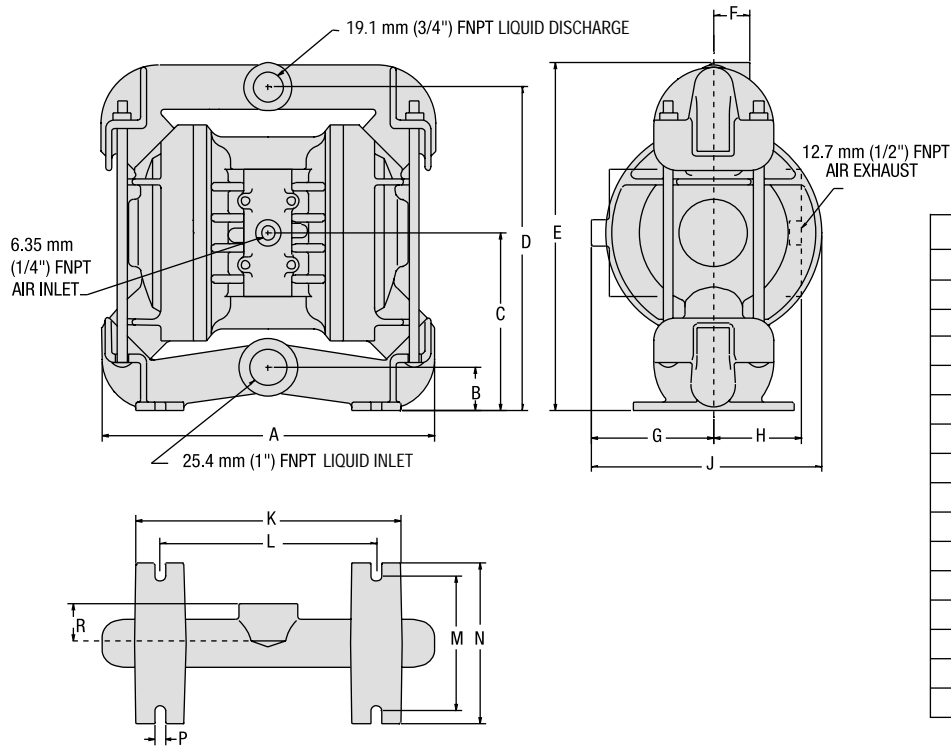

DIMENSIONS - 84811 & 84812		
ITEM	METRIC (mm)	STANDARD (inch)
A	268	10.53
B	37	1.43
C	138	5.43
D	254	10.00
E	279	11.00
F	29	1.12
G	95	3.75
H	77	3.03
J	184	7.25
K	210	8.25
L	172	6.75
M	106	4.18
N	127	5.00
P	8	0.31
R	32	1.25

## SECTION 3B

# DIMENSIONAL DRAWING

## MODEL 84813

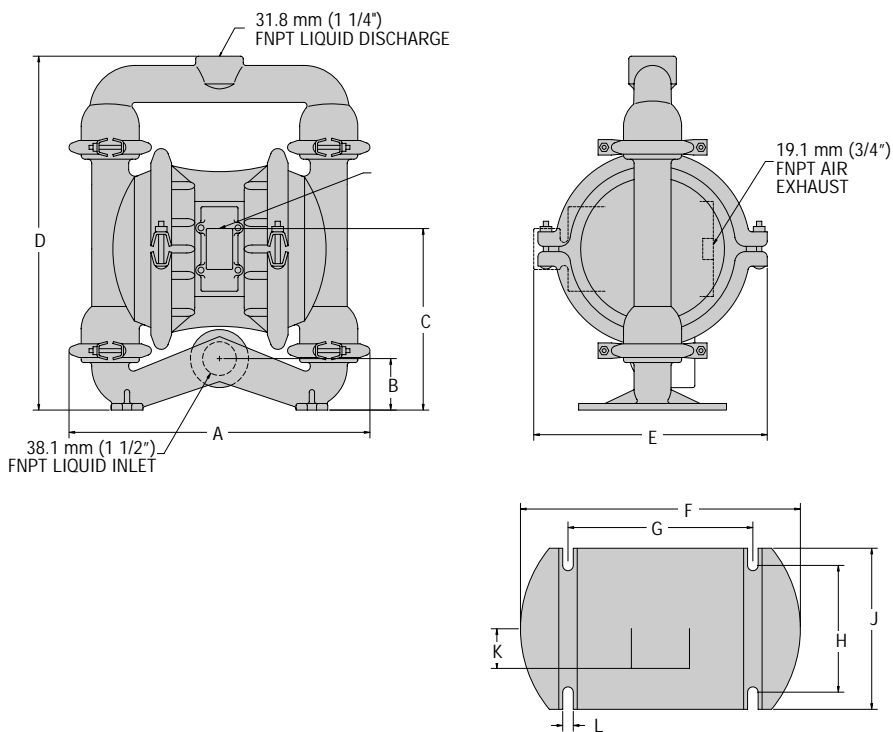

DIMENSIONS - 84813		
ITEM	METRIC (mm)	STANDARD (inch)
A	391	15.38
B	63	2.47
C	219	8.63
D	442	17.41
E	285	11.22
F	336	13.22
G	222	8.75
H	151	5.94
J	195	7.66
K	49	1.91
L	13	.50

## SECTION 4A

# PERFORMANCE CURVES MODEL 84811 RUBBER-FITTED

Height.....279.4 mm (11")  
 Width.....267.5 mm (10.53")  
 Depth.....184.2 mm (7.25")  
 Ship Weight .....Aluminum 12 kg (26 lbs.)  
 Air Inlet .....6.35 mm (¼")  
 Inlet .....25.4 mm (1")  
 Outlet .....19.1 mm (¾")  
 Suction Lift .....5.18 m Dry (17')  
                                   9.45 m Wet (31')

### Displacement per

Stroke ..... .41 l (0.105 gal.)<sup>1</sup>  
 Max. Flow Rate.....132.49 lpm (35 gpm)  
 Max. Size Solids.....3.18 mm (⅛")

<sup>1</sup>Displacement per stroke was calculated at 4.8 Bar (70 psig) air inlet pressure against a 2 Bar (30 psig) head pressure.

**Example:** To pump 68.1 lpm (18 gpm) against a discharge pressure head of 2.7 Bar (40 psig) requires 4.1 Bar (60 psig) and 18.7 Nm<sup>3</sup>/h (11 scfm) air consumption. (See dot on chart.)

**Caution:** Do not exceed 3.4 Bar (50 psig) air supply pressure.

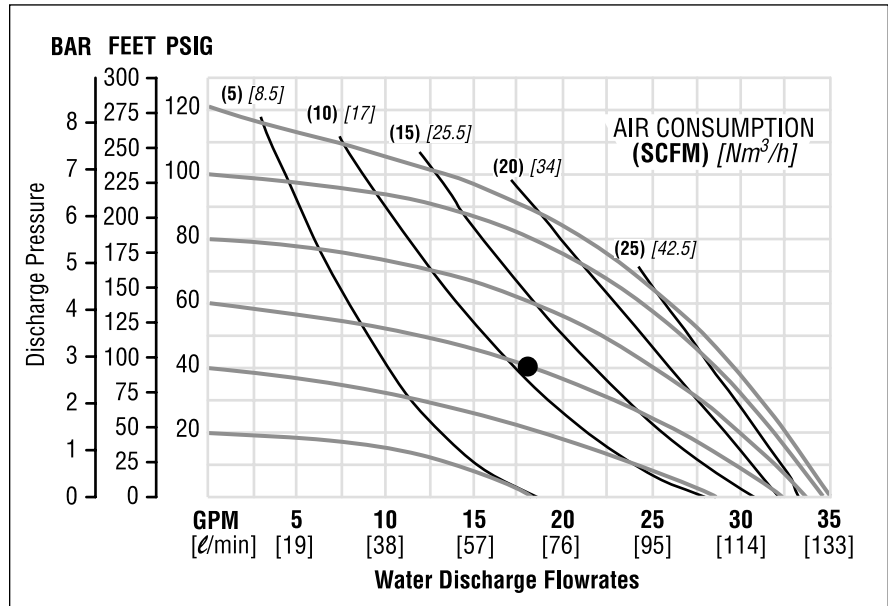

Flow rates indicated on chart were determined by pumping water.

For optimum life and performance, pumps should be specified so that daily operation parameters will fall in the center of the pump performance curve.

## SECTION 4B

# PERFORMANCE CURVES MODEL 84812 TEFLON®-FITTED

Height.....279.4 mm (11")  
 Width.....267.5 mm (10.53")  
 Depth.....184.2 mm (7.25")  
 Ship Weight .....Aluminum 12 kg (26 lbs.)  
 Air Inlet .....6.35 mm (¼")  
 Inlet .....25.4 mm (1")  
 Outlet .....19.1 mm (¾")  
 Suction Lift .....1.83 m Dry (6')  
                                   9.45 m Wet (31')

### Displacement per

Stroke ..... .19 l (0.05 gal.)<sup>1</sup>  
 Max. Flow Rate.....94.64 lpm (25 gpm)  
 Max. Size Solids.....3.18 mm (⅛")

<sup>1</sup>Displacement per stroke was calculated at 4.8 Bar (70 psig) air inlet pressure against a 2 Bar (30 psig) head pressure.

**Example:** To pump 45.4 lpm (12 gpm) against a discharge pressure head of 2.7 Bar (40 psig) requires 4.1 Bar (60 psig) and 22.1 Nm<sup>3</sup>/h (13 scfm) air consumption. (See dot on chart.)

**Caution:** Do not exceed 3.4 Bar (50 psig) air supply pressure.

**⚠ CAUTION**

Do not exceed 50 PSIG air supply pressure.

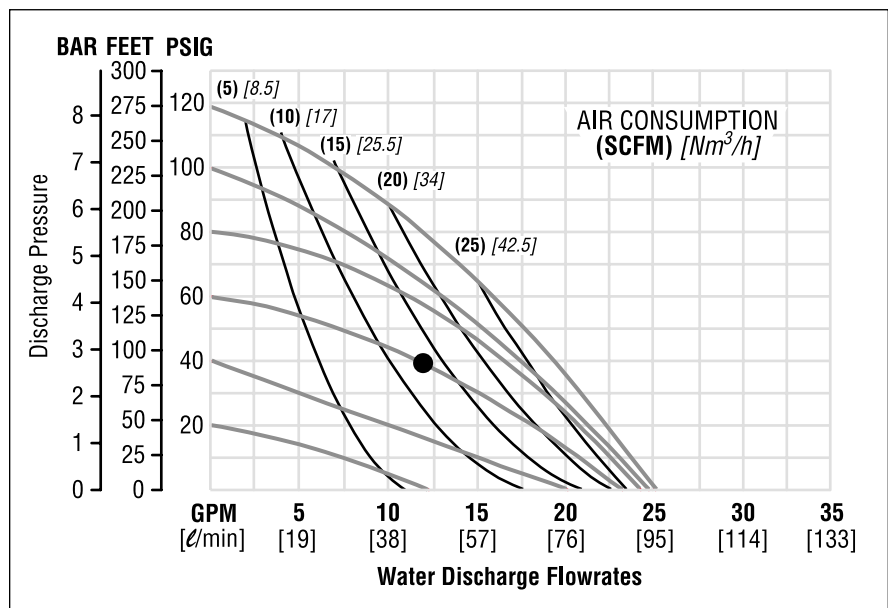

Flow rates indicated on chart were determined by pumping water.

For optimum life and performance, pumps should be specified so that daily operation parameters will fall in the center of the pump performance curve.

# SECTION 4C

## PERFORMANCE CURVES MODEL 84813 RUBBER-FITTED

Height.....454.0 mm (17.87")  
 Width.....369.1 mm (14.53")  
 Depth.....287.4 mm (11.31")  
 Ship Weight.....Aluminum 17.5 kg (38 lbs.)  
 Air Inlet .....12.7 mm (½")  
 Inlet .....38.1 mm (1½")  
 Outlet .....31.8 mm (1¼")  
 Suction Lift.....5.49 m (18')  
 8.53 m (28')

Displacement per  
 Stroke ..... 1.02 l (0.27 gal.)<sup>1</sup>  
 Max. Flow Rate.....287.7 lpm (76 gpm)  
 Max. Size Solids.....4.8 mm (¾")

<sup>1</sup>Displacement per stroke was calculated at 4.8 Bar (70 psig) air inlet pressure against a 2 Bar (30 psig) head pressure.

**Example:** To pump 113.6 lpm (30 gpm) against a discharge pressure head of 2.7 Bar (40 psig) requires 4.1 Bar (60 psig) and 25.5 Nm<sup>3</sup>/h (15 scfm) air consumption. (See dot on chart.)

**Caution:** Do not exceed 3.4 Bar (50 psig) air supply pressure.

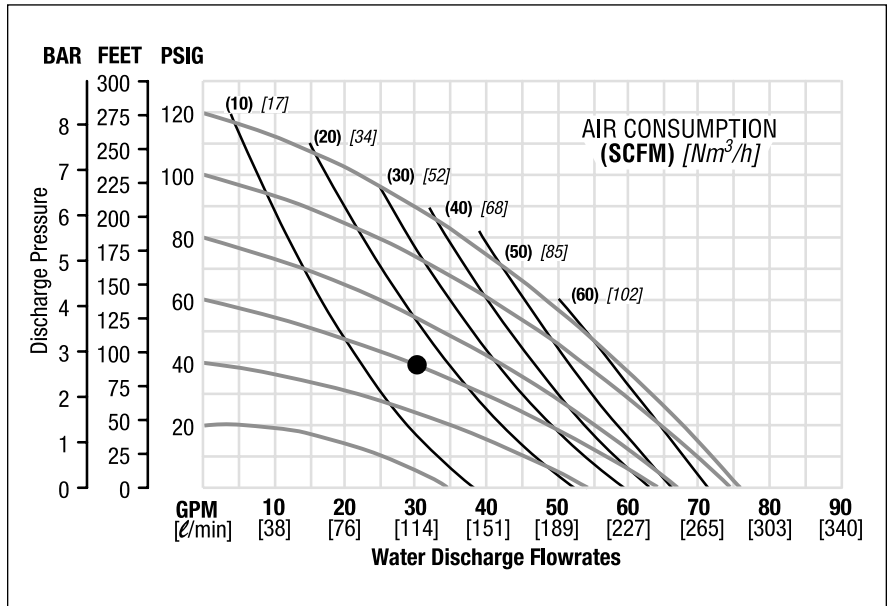

Flow rates indicated on chart were determined by pumping water.

For optimum life and performance, pumps should be specified so that daily operation parameters will fall in the center of the pump performance curve.

**⚠ CAUTION**

Do not exceed 50 PSIG air supply pressure.

SECTION 5A

SUCTION LIFT CURVES  
MODELS 84811 & 84812

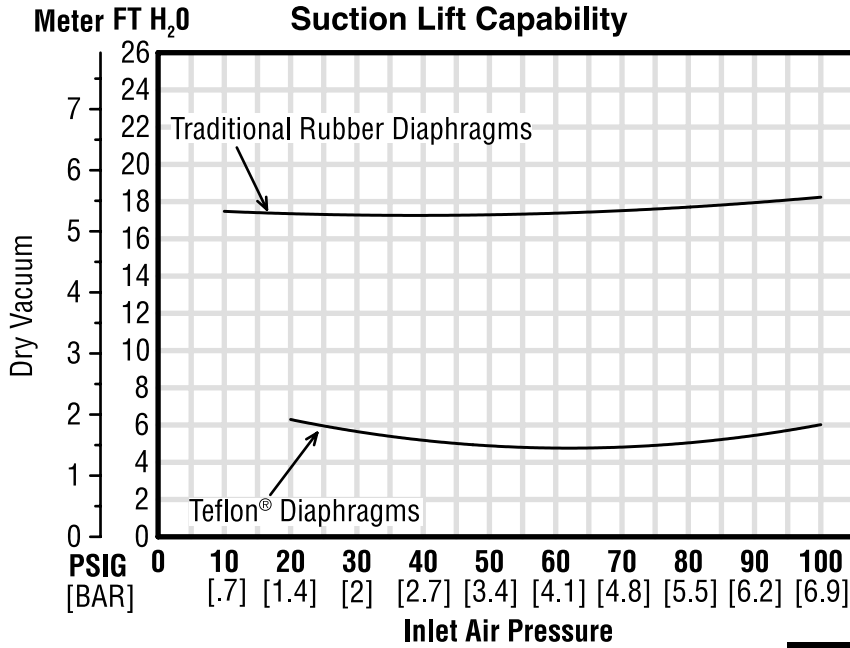

**CAUTION**  
Do not exceed 50 PSIG air supply pressure.

SECTION 5B

SUCTION LIFT CURVES  
MODEL 84813

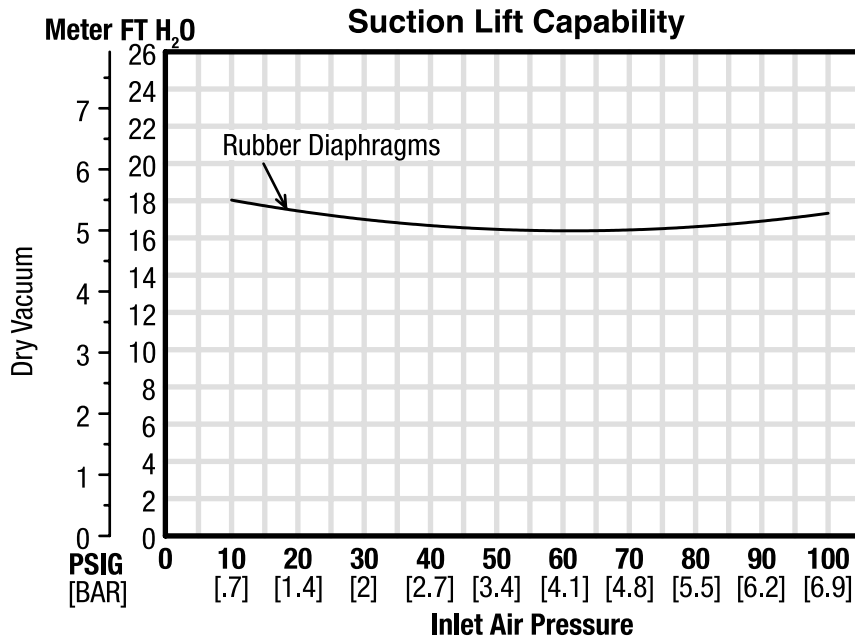

Suction lift curves are calibrated for pumps operating at 1,000' (305 m) above sea level. This chart is meant to be a guide only. There are many variables which can affect your pump's operating characteristics. The number of intake and discharge elbows,

viscosity of pumping fluid, elevation (atmospheric pressure) and pipe friction loss all affect the amount of suction lift your pump will attain.

# SECTION 6A

## INSTALLATION

---

The suction pipe size should be as large as pump inlet diameter or larger if highly viscous material is being pumped. The suction hose must be non-collapsible, reinforced type as the pump is capable of pulling a high vacuum. Discharge piping should be as large as discharge of pump; larger diameter can be used to reduce friction losses. It is critical that all fittings and connections are airtight or a reduction or loss of pump suction capability will result.

**INSTALLATION:** Months of careful planning, study, and selection efforts can result in unsatisfactory pump performance if installation details are left to chance.

Premature failure and long term dissatisfaction can be avoided if reasonable care is exercised throughout the installation process.

**LOCATION:** Noise, safety, and other logistical factors usually dictate that "utility" equipment be situated away from the production floor. Multiple installations with conflicting requirements can result in congestion of utility areas, leaving few choices for siting of additional pumps.

Within the framework of these and other existing conditions, every pump should be located in such a way that four key factors are balanced against each other to maximum advantage.

1. **ACCESS:** First of all, the location should be accessible. If it's easy to reach the pump, maintenance personnel will have an easier time carrying out routine inspections and adjustments. Should major repairs become necessary, ease of access can play a key role in speeding the repair process and reducing total downtime.

2. **AIR SUPPLY:** Every pump location should have an air line large enough to supply the volume of air necessary to achieve the desired pumping rate (see pump performance chart). Use air pressure up to a maximum of 3.4 Bar (50 psi) depending upon pumping requirements. The use of an air filter before the pump will ensure that the majority of any pipeline contaminants will be eliminated. For best results, the pumps should use an air filter, regulator, and lubricator system.

3. **SOLENOID OPERATION:** the pumps should use a 5 micron air filter, needle valve and regulator. The use of an air filter before the pump will ensure that the majority of any pipeline contaminants will be eliminated.

4. **ELEVATION:** Selecting a site that is well within the pump's suction lift capability will assure that loss-of-prime troubles will be eliminated. In addition, pump efficiency can be adversely affected if proper attention is not given to elevation (see pump performance chart).

5. **PIPING:** Final determination of the pump site should not be made until the piping problems of each possible location have been evaluated. The impact of current and future installations should be considered ahead of time to make sure that inadvertent restrictions are not created for any remaining sites.

The best choice possible will be a site involving the shortest and the straightest hook-up of suction and discharge piping. Unnecessary elbows, bends, and fittings should be avoided. Pipe sizes should be selected so as to keep friction losses within practical limits. All piping should be supported independently of the pump. In addition, it should line up without placing stress on the pump fittings.

Expansion joints can be installed to aid in absorbing the forces created by the natural reciprocating action of the pump. If the pump is to be bolted down to a solid foundation, a mounting pad placed between the pump and foundation will assist in minimizing pump vibration. Flexible connections between the pump and rigid piping will also assist in minimizing pump vibration. If quick-closing valves are installed at any point in the discharge system, or if pulsation within a system becomes a problem, a surge suppressor should be installed to protect the pump, piping and gauges from surges and water hammer.

When pumps are installed in applications involving flooded suction or suction head pressures, a gate valve should be installed in the suction line to permit closing of the line for pump service.

The pump can be used in submersible applications only when both wetted and non-wetted portions are compatible with the material being pumped. If the pump is to be used in a submersible application, a hose should be attached to the pump's air exhaust and the exhaust air piped above the liquid level.

If the pump is to be used in a self-priming application, be sure that all connections are airtight and that the suction lift is within the pump's ability. Note: Materials of construction and elastomer material have an effect on suction lift parameters. Please refer to pump performance data.

Pumps in service with a positive suction head are most efficient when inlet pressure is limited to .5-.7 Bar (7-10 psig). Premature diaphragm failure may occur if positive suction is .8 Bar (11 psig) and higher.

**CAUTION: DO NOT EXCEED 3.4 BAR (50 PSIG) AIR SUPPLY PRESSURE.**

**PUMPS SHOULD BE THOROUGHLY FLUSHED WITH WATER BEFORE INSTALLING INTO PROCESS LINES.**

**BLOW OUT AIR LINE FOR 10 TO 20 SECONDS BEFORE ATTACHING TO PUMP TO MAKE SURE ALL PIPE LINE DEBRIS IS CLEAR. ALWAYS USE AN IN-LINE AIR FILTER.**

### **WARNING**

FAILURE TO HEED THE FOLLOWING INSTRUCTIONS MAY RESULT IN SERIOUS PERSONAL AND/OR PROPERTY HARM.

Installation and use must be in accordance with the Flammable and Combustible Liquid Code (NFPA 30) and Automotive and Marine Service Station Code (NFPA 30A) and must comply with ALL Federal, State and Local codes.

Consult your fluid suppliers to assure the fluids being used in conjunction with this pump are compatible with the wetted parts.

# SUGGESTED INSTALLATION

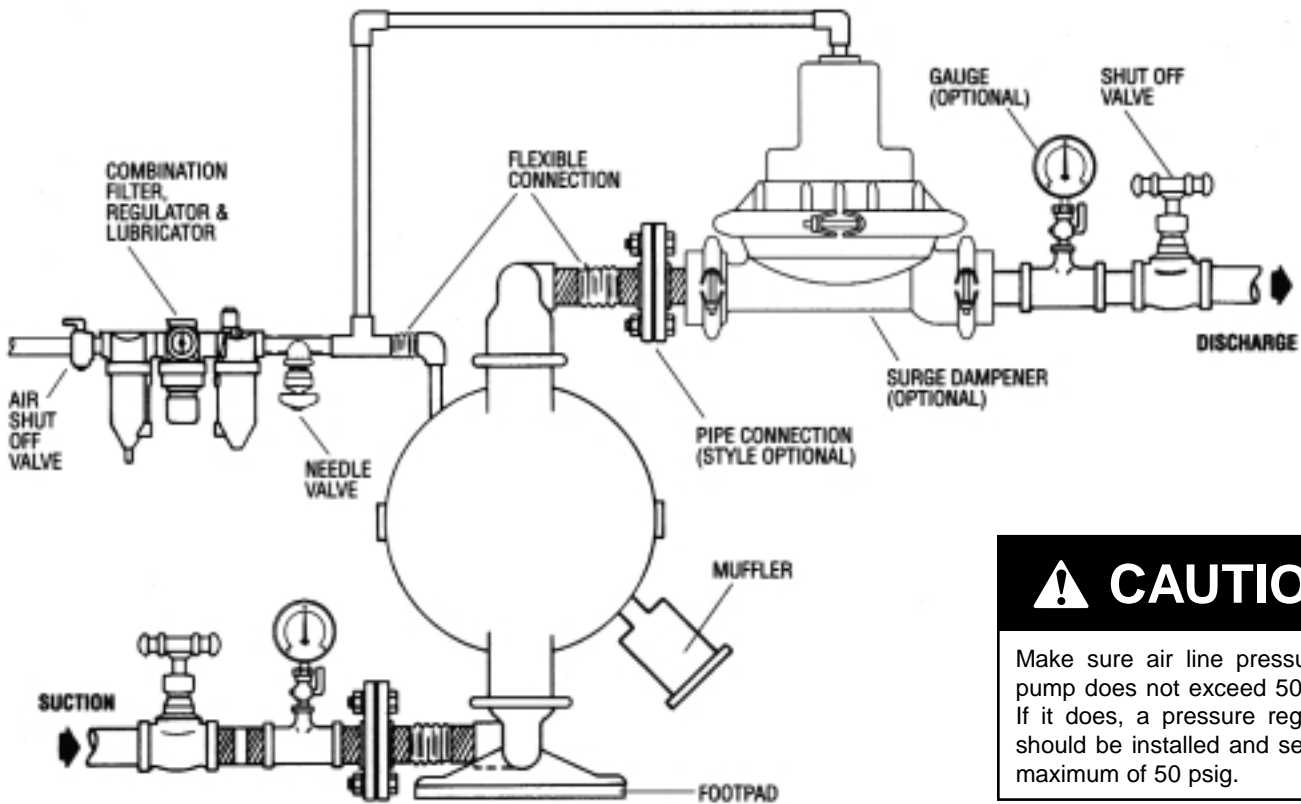

**CAUTION**

Make sure air line pressure to pump does not exceed 50 psig. If it does, a pressure regulator should be installed and set at a maximum of 50 psig.

To stop the pump from operating in an emergency situation, simply close the "shut-off" valve (user supplied) installed in the air supply line. A properly functioning valve will stop the air supply to the pump, therefore stopping output. This "shut-off" valve should be located far enough away from the pumping equipment such that it can be reached safely in an emergency situation.

## SECTION 6B

# SUGGESTED OPERATION AND MAINTENANCE INSTRUCTIONS

**OPERATION:** Pump discharge rate can be controlled by limiting the volume and/or pressure of the air supply to the pump (preferred method). An air regulator is used to regulate air pressure. A needle valve is used to regulate volume. Pump discharge rate can also be controlled by throttling the pump discharge by partially closing a valve in the discharge line of the pump. This action increases friction loss which reduces flow rate. This is useful when the need exists to control the pump from a remote location. When the pump discharge pressure equals or exceeds the air supply pressure, the pump will stop; no bypass or pressure relief valve is needed, and pump damage will not occur. The pump has reached a "deadhead" situation and can be restarted by reducing the fluid discharge pressure or increasing the air inlet pressure. The pump runs solely on compressed air and does not generate heat, therefore your process fluid temperature will not be affected.

**RECORDS:** When service is required, a record should be made of all necessary repairs and replacements. Over a period of time, such records can become a valuable tool for predicting and preventing future maintenance problems and unscheduled downtime. In addition, accurate records make it possible to identify pumps that are poorly suited to their applications.

**MAINTENANCE AND INSPECTIONS:** Since each application is unique, maintenance schedules may be different for every pump. Frequency of use, line pressure, viscosity and abrasiveness of process fluid all affect the parts life of a pump. Periodic inspections have been found to offer the best means for preventing unscheduled pump downtime. Personnel familiar with the pump's construction and service should be informed of any abnormalities that are detected during operation.

# SECTION 6C

## TROUBLESHOOTING

---

### ***Pump will not run or runs slowly.***

1. Check air inlet screen and air filter for debris.
2. Check for sticking air valve, flush air valve in solvent.
3. Check for worn out air valve. If piston face in air valve is shiny instead of dull, air valve is probably worn beyond working tolerances and must be replaced.
4. Check center block Glyd™ rings. If worn excessively, they will not seal and air will simply flow through pump and out air exhaust. Use only Lincoln Glyd™ rings as they are of special construction.
5. Check for rotating piston in air valve.
6. Check type of lubricant being used. A higher viscosity oil than suggested may cause the piston to stick or run erratically. Lincoln suggests the use of a hydraulic oil with arctic characteristics (ISO 15-5 wt).

### ***Pump runs but little or no product flows.***

1. Check for pump cavitation; slow pump speed down to match thickness of material being pumped.
2. Check for sticking ball checks. If material being pumped is not compatible with pump elastomers, swelling may occur. Replace ball checks and O-rings with proper elastomers.
3. Check to make sure all suction connections are air tight, especially clamp bands around intake balls.

### ***Pump air valve freezes.***

Check for excessive moisture in compressed air. Either install dryer or hot air generator for compressed air.

### ***Air bubbles in pump discharge.***

1. Check for ruptured diaphragm.
2. Check tightness of clamp bands, especially at intake manifold (model 84813 only).

### ***Product comes out air exhaust.***

1. Check for diaphragm rupture.
2. Check tightness of piston plates to shaft.

### ***Pump rattles.***

1. Create false discharge head or suction lift.

## SECTION 7A

# MODEL 84811 & 84812

## DIRECTIONS FOR DISASSEMBLY/REASSEMBLY

**CAUTION:** Before any maintenance or repair is attempted, the compressed air line to the pump should be disconnected and all air pressure allowed to bleed from the pump. Disconnect all intake, discharge, and air lines. Drain the pump by turning it upside down and allowing any fluid to flow into a suitable container. Be aware of any hazardous effects of contact with your process fluid.

The model 84811 and 84812 have a 2.54 cm (1") inlet and 1.91 cm ( $\frac{3}{4}$ ") outlet and are designed for flows up to 132.49 lpm (35 gpm). The single-piece center section, consisting of center block and air chambers, is molded of aluminum. The air valve is manufactured of brass. All O-rings used in the pump are of a special material and shore hardness that should only be replaced with factory-supplied parts.

### TOOLS REQUIRED:

Adjustable Wrench

$\frac{5}{16}$ " Box Wrench

$\frac{3}{4}$ " Box Wrench

Vise equipped with soft jaws (such as plywood, plastic or other suitable material)

**NOTE:** The model used for these instructions incorporates rubber diaphragms, balls, and seats. Models with Teflon® diaphragms, balls and seats are the same except where noted.

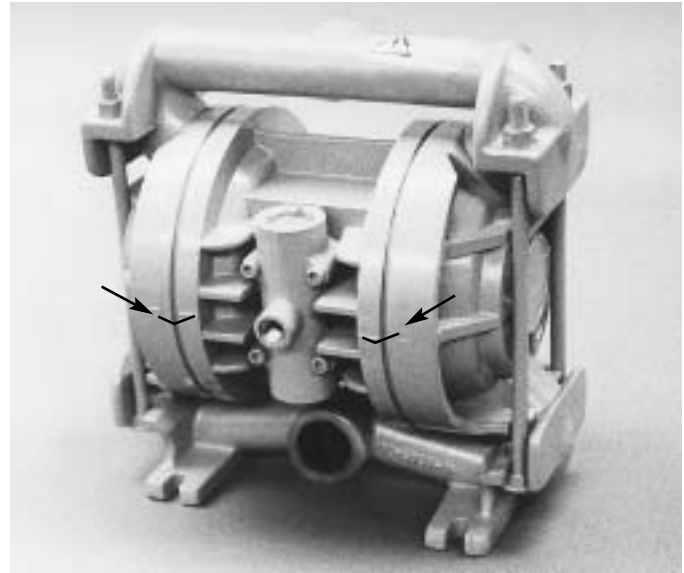

### DISASSEMBLY:

Figure 1

#### Step 1.

Before starting disassembly, mark a line from each liquid chamber to its corresponding air chamber. This line will assist in proper alignment during reassembly. (Figure 1)

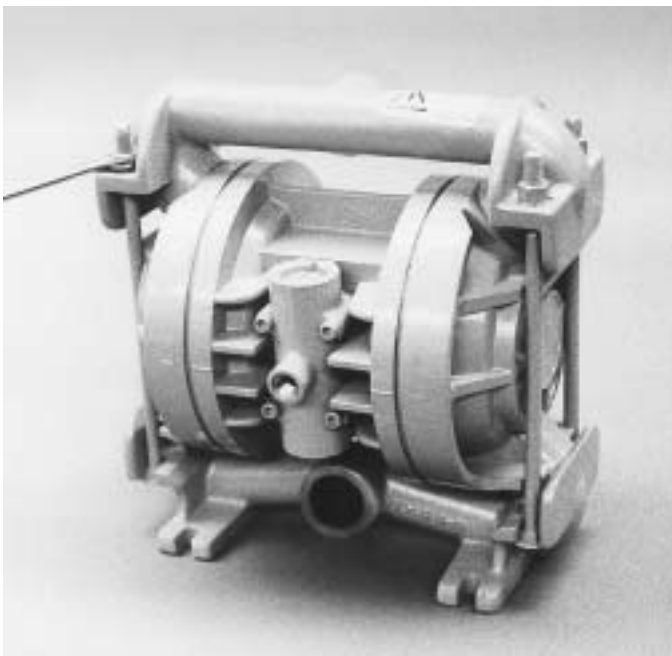

#### Step 2.

Figure 2

Utilizing the  $\frac{5}{16}$ " box wrench, start by removing the four long carriage bolts that secure the top and bottom manifolds to the center section. (Figure 2)

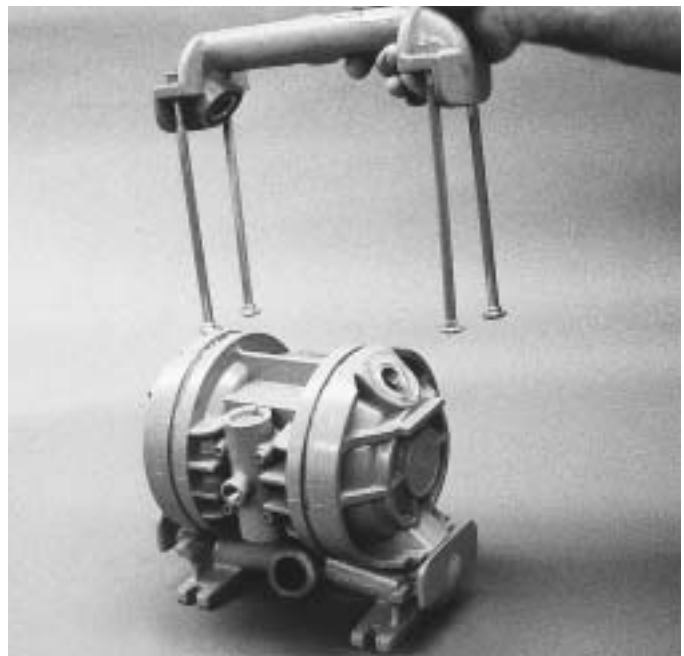

#### Step 3.

Figure 3

Remove the top manifold and lift the center section off the inlet manifold. (Figure 3)

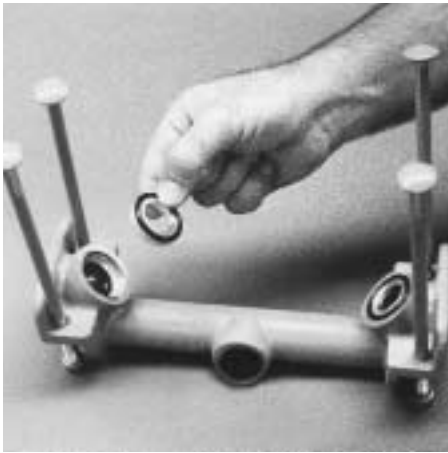

**Step 4.** *Figure 4*

Remove the discharge valve balls, seats and O-rings from the discharge manifold and inspect for nicks, gouges, chemical attack or abrasive wear. Replace worn parts with genuine Wilden parts for reliable performance. Teflon® O-rings should be replaced when reassembled. (Figure 4)



**Step 5.** *Figure 5*

Inspect the valve seat, valve seat O-ring, and valve ball from intake manifold. Check for nicks, gouges, chemical attack or abrasive wear. Replace worn parts with genuine Wilden parts for reliable performance. Teflon® O-rings should be replaced when reassembled. (Figure 5)



**Step 6.** *Figure 6*

With the 3/4" box wrench or by rotating the diaphragm by hand, remove the diaphragm assembly. (Figure 6)



**Step 7.** *Figure 7*

**NOTE:** Due to varying torque values, one of the following two situations may occur: 1) The outer piston, diaphragm and inner piston remain attached to the shaft and the entire assembly can be removed from the center section (Figure 7).



**Step 8.** *Figure 8*

2) The outer piston, diaphragm, inner piston, and disc spring separate from the shaft which remains connected to the opposite side diaphragm assembly (Figure 8). Teflon®-fitted pumps come standard with back-up diaphragms (not shown).



**Step 9.** *Figure 9*

To remove the diaphragm assembly from the shaft, secure shaft with soft jaws (a vise fitted with plywood or other suitable material) to ensure shaft is not nicked, scratched, or gouged. Using an adjustable wrench, remove diaphragm assembly from shaft. Inspect all parts for wear and replace with genuine Lincoln parts if necessary. (Figure 9)

## SECTION 7B

# MODEL 84813

## DIRECTIONS FOR DISASSEMBLY/REASSEMBLY

**CAUTION:** Before any maintenance or repair is attempted, the compressed air line to the pump should be disconnected and all air pressure allowed to bleed from the pump. Disconnect all intake, discharge, and air lines. Drain the pump by turning it upside down and allowing any fluid to flow into a suitable container. Be aware of any hazardous effects of contact with your process fluid.

The model 84813 has a 38.1 mm (1½") inlet and 31.8 mm (1¼") outlet and is designed for flows up to 287.7 lpm (76 gpm). The model 84813 is available with aluminum wetted parts. The air valve is manufactured of brass. All O-rings used in the pump are of a special material and shore hardness which should only be replaced with factory-supplied parts.

### TOOLS REQUIRED:

Adjustable Wrench

½" Wrench

¾" Box Wrench

⅜" Allen Wrench

Vise equipped with soft jaws (such as plywood, plastic or other suitable material)



### DISASSEMBLY:

Figure 1

#### Step 1.

Before starting disassembly, mark a line from each liquid chamber to its corresponding air chamber. This line will assist in proper alignment during reassembly. (Figure 1)

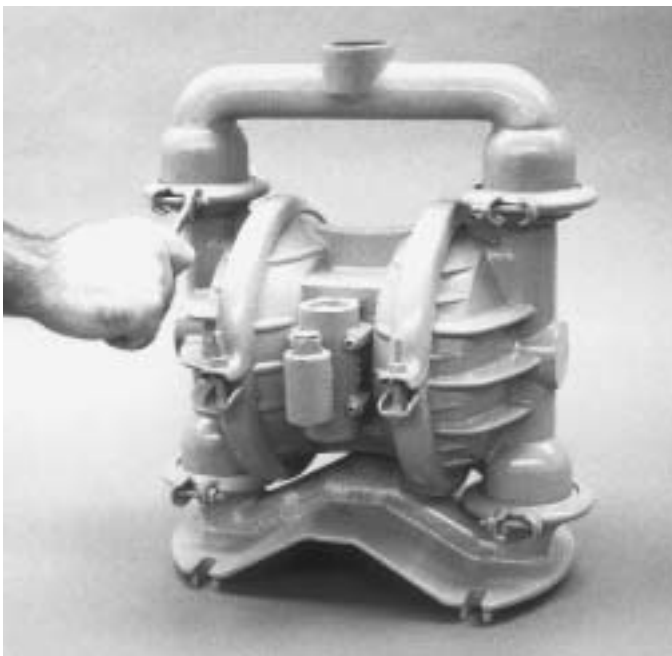

#### Step 2.

Figure 2

Utilizing a ½" wrench, remove the two small clamp bands that fasten the discharge manifold to the liquid chambers. (Figure 2)

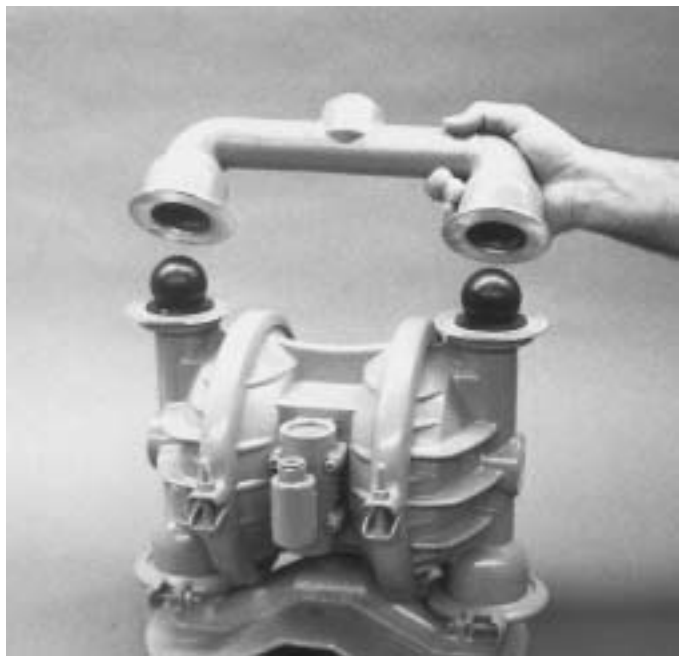

#### Step 3.

Figure 3

Lift away the discharge manifold to expose the valve balls and seats. (Figure 3)

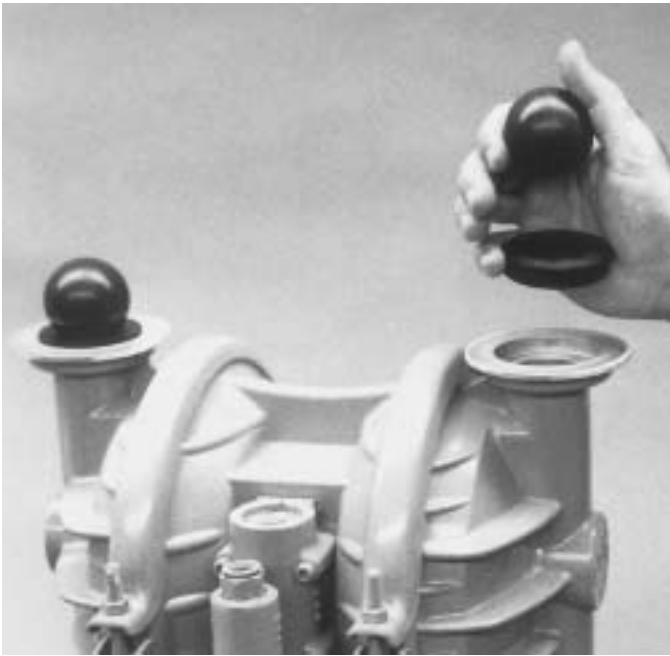

**Step 4.** *Figure 4*

Remove the discharge valve balls and seats (*Figure 4*) from the liquid chambers and inspect for nicks, gouges, chemical attack or abrasive wear. Replace worn parts with genuine Wilden parts for reliable performance.

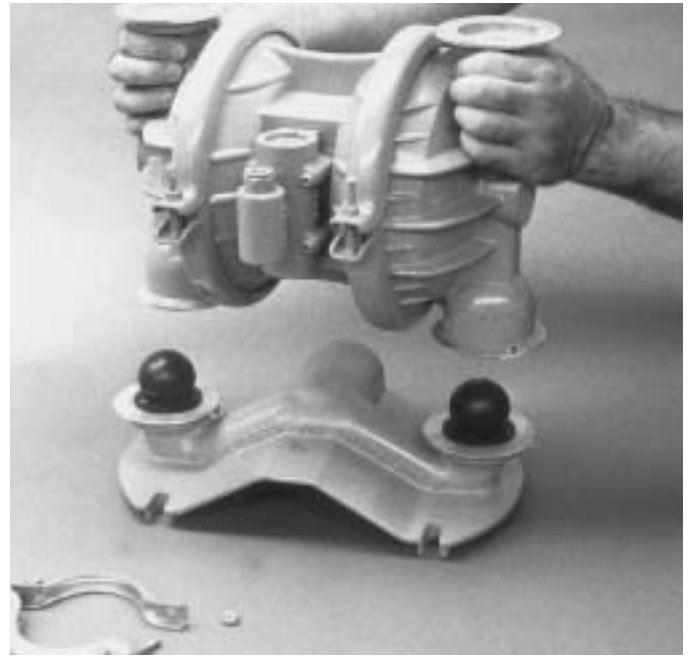

**Step 5.** *Figure 5*

Remove the two small clamp bands, which fasten the intake manifold to the liquid chambers. Lift liquid chambers and center section from intake manifold to expose intake valve balls and seats. (*Figure 5*)

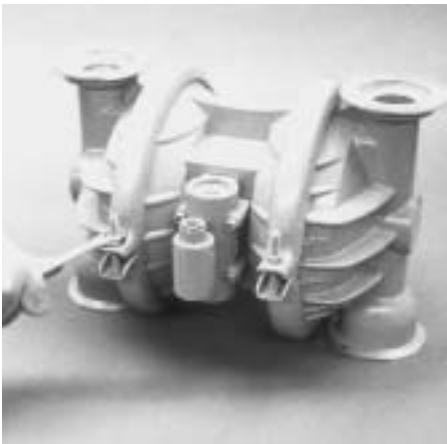

**Step 6.** *Figure 6*

Remove one set of large clamp bands which secure one liquid chamber to the center section. (*Figure 6*).



**Step 7.** *Figure 7*

Lift liquid chamber away from center section to expose diaphragm and outer piston. (*Figure 7*)



**Step 8.** *Figure 8*

Using an adjustable wrench, or by rotating the diaphragm by hand, remove the diaphragm assembly. (*Figure 8*)



**Step 9A.**

*Figure 9A*



*Figure 9B*



**Step 10.**

*Figure 10*

**NOTE:** Due to varying torque values, one of the following two situations may occur: 1) The outer piston, diaphragm and inner piston remain attached to the shaft and the entire assembly can be removed from the center section (*Figure 9A*);

2) The outer piston, diaphragm and inner piston separate from the shaft which remains connected to the opposite side diaphragm assembly (*Figure 9B*). Repeat disassembly instructions for the opposite liquid chamber. Inspect diaphragm assembly and shaft for signs of wear or chemical attack. Replace all worn parts with genuine Lincoln parts for reliable performance.

To remove diaphragm assembly from shaft, secure shaft with soft jaws (a vise fitted with plywood or other suitable material) to ensure shaft is not nicked, scratched or gouged. Using an adjustable wrench, remove diaphragm assembly from shaft. (*Figure 10*)

## SECTION 7C

# REASSEMBLY HINTS & TIPS

### ASSEMBLY:

Upon performing applicable maintenance to the air distribution system, the pump can now be reassembled. Please refer to the disassembly instructions for photos and parts placement. To reassemble the pump, follow the disassembly instructions in reverse order. The air distribution system needs to be assembled first, then the diaphragms and finally the wetted path. Please find the applicable torque specifications on this page. The following tips will assist in the assembly process.

- Clean the inside of the center section shaft bushing to ensure no damage is done to new seals.
- Stainless bolts should be lubed to reduce the possibility of seizing during tightening.
- Be sure to tighten outer pistons simultaneously on Teflon®-fitted pumps to ensure proper torque values.

### MAXIMUM TORQUE SPECIFICATIONS, MODEL 84811 & 84812

Description of Part	Metal Pumps
Air Valve	3.4 m-N [30 in.-lbs.]
Outer Piston, Rubber and Teflon®-Fitted	38 m-N [28 ft.-lbs.]
Vertical Bolts	13.0 m-N [115 in.-lbs.]

### MAXIMUM TORQUE SPECIFICATIONS, MODEL 84813

Description of Part	Metal Pumps
Air Valve	3.2 m-N [28 in.-lbs.]
Outer Piston	38 m-N [28 ft.-lbs.]
Small Clamp Band	3.4 m-N [30 in.-lbs.]
Large Clamp Band	10.7 m-N [95 in.-lbs.]
Center Block Assembly	8.5 m-N [75 in.-lbs.]

## SECTION 7D

# AIR VALVE / CENTER SECTION REPAIR / MAINTENANCE

The air valve assembly consists of the air valve body and piston. The unique design of the air valve relies only on differential pressure to cause the air valve to shift. It is reliable and simple to maintain. The bushing in the center block, along with the diaphragm shaft, provides the "trigger" to tell the air valve to shift. The following procedure will ensure that the air valve on your Lincoln pump will provide long trouble-free service.

### AIR VALVE BODY AND PISTON ASSEMBLY AND DISASSEMBLY

The air valve body and piston can be disconnected from the pump by removing the four socket-head cap screws which attach it to the center section. The piston in the air valve is aluminum with a dark anodized coating. The piston should move freely and the ports in the piston should line up with the ports on the face of the air valve body. The piston should also appear to be dull black in color. If the piston appears to be a shiny aluminum color, the air valve is probably worn beyond working tolerances and should be replaced.

If the piston does not move freely in the air valve, the entire air valve should be immersed in a cleaning solution. (NOTE: Do not

force the piston by inserting a metal object.) This soaking should remove any accumulation of sludge and grit which is preventing the air valve piston from moving freely. If the air valve piston does not move freely after the above cleaning, the air valve should be disassembled as follows: Remove the snap ring from the top end of the air valve and apply an air jet alternately to the two holes located in the face of the air valve until the end cap is blown out. **[CAUTION:** The air valve end cap may come out with considerable force. Hand protection such as a padded glove or a rag should be used to capture the end cap.] Inspect the piston and cylinder bore for nicks and scoring.

Small nicks can usually be dressed out and the piston returned to service. Inspect the cylinder end caps. Make sure that the guide pin is straight and smooth or the piston will not move freely in the cylinder. Clean out anti-centering pin holes located on each side of the piston. Pin holes are located on each side of the annular groove on the top of the piston and travel to each end. New O-rings should be installed on the end caps. Lubricate the O-rings and install the end caps, assuring that proper alignment of the piston and cylinder ports are maintained. Use an oil with arctic characteristics (ISO 15-5wt).

### GLYD™ RING REPLACEMENT/ CENTER SECTION

The pump's center section consists of a molded housing with a bronze bushing. (Bushing is not removable.) This bushing has grooves cut into the inside diameter. Glyd™ rings are installed in these grooves. When the Glyd™ rings become worn, they will no longer seal and must be replaced.

Grooves In  
Bushing Which  
Contain Glyd™ Rings

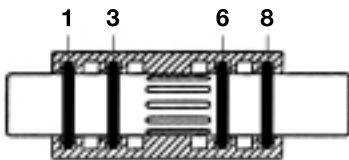

Model 84811 & 84812

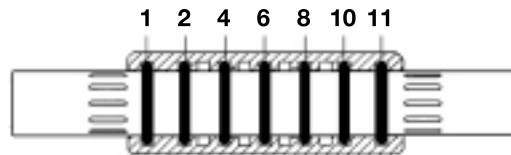

Model 84813

SECTION 8A

EXPLODED VIEW/PARTS LISTING

MODELS  
84811  
& 84812

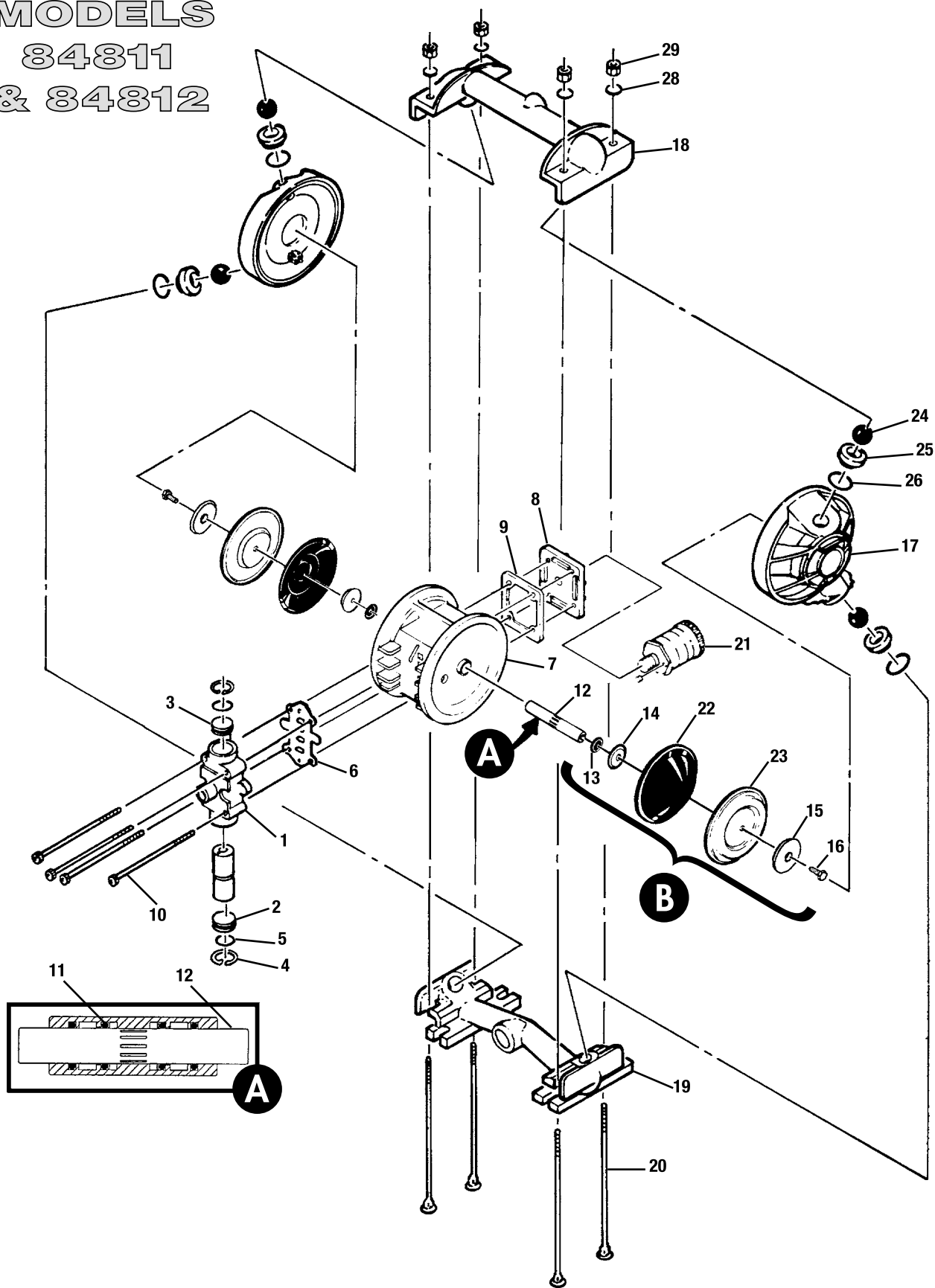

## Model 84811 & 84812 Metal Air-Operated Pumps

Item #	Description	Qty. Per Pump	84811	84812
			P/N	P/N
<b>1</b>	<b>Air Valve Assembly<sup>1</sup></b>	<b>1</b>	<b>244152</b>	<b>244152</b>
2	Air Valve Cap wo/Guide (bottom)	1	245565	245565
3	Air Valve Cap w/Guide (top)	1	245564	245564
4	Snap Ring	2	245563	245563
5	Air Valve Cap O-Ring	2	244154	244154
6	Air Valve Gasket - Buna-N	1	244148	244148
7	Center Section	1	272326	272326
8	Muffler Plate	1	272327	272327
9	Muffler Plate Gasket - Buna-N	1	244147	244147
10	Air Valve Screws	4	245566	245566
<b>11</b>	<b>Center Section Glyd Ring</b>	<b>4</b>	<b>244157</b>	<b>244157</b>
12	Shaft	1	244145	244145
13	Disc Spring	2	272328	272328
14	Pistons - Inner	2	272329	272332
15	Pistons - Outer	2	272330	272333
16	Stud/Bolt	2	N/R	272334
17	Liquid Chamber	2	272331	272335
18	Discharge Manifold	1	245567	245567
19	Inlet Manifold	1	245562	245562
20	Manifold Bolt 3/8"-16 x 8 1/2"	4	245561	245561
21	Muffler	1	244141	244141
<b>22</b>	<b>Back-Up Diaphragm</b>	<b>2</b>	<b>N/R</b>	<b>244158</b>
<b>23</b>	<b>Diaphragm</b>	<b>2</b>	<b>244142</b>	<b>244143</b>
<b>24</b>	<b>Valve Balls</b>	<b>4</b>	<b>244136</b>	<b>244137</b>
<b>25</b>	<b>Valve Seat</b>	<b>4</b>	<b>244138</b>	<b>244138</b>
<b>26</b>	<b>Valve Seat O-Ring</b>	<b>4</b>	<b>244139</b>	<b>244140</b>
27	Hex Nut 1/4"-20, S.S. (not shown)	4	244141	244141
28	Manifold Bolt Washer 3/8"	4	245592	245592
29	Manifold Bolt Nut 3/8"-16	4	245591	245591

All bold face items are primary wear parts.

<sup>1</sup>Air Valve Assembly includes items 2, 3, 4 and 5.

Model 84811 is aluminum wetted path with Buna-N elastomers.

Model 84812 is aluminum wetted path with Teflon® elastomers.

SECTION 8B

EXPLODED VIEW/PARTS LISTING

MODEL  
84813

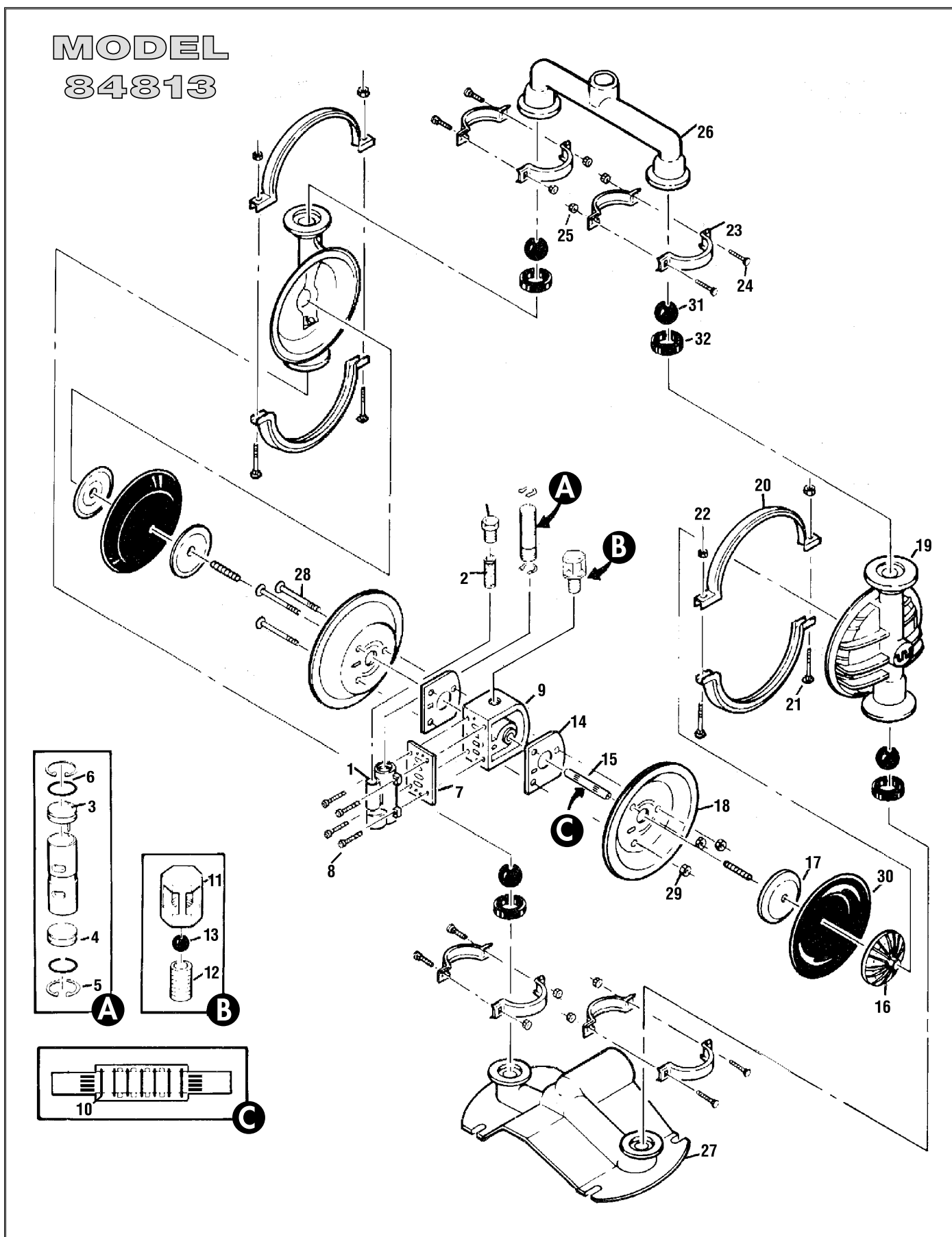

## Model 84813 Metal Air-Operated Pumps

Item #	Description	Qty. Per Pump	84813
			P/N
<b>1</b>	<b>Air Valve Assembly<sup>1</sup></b>	<b>1</b>	<b>244124</b>
2	Air Valve Screen	1	244125
3	Air Valve Cap w/Guide (top)	1	245579
4	Air Valve Cap wo/Guide (bottom)	1	245580
5	Snap Ring	2	245581
6	Air Valve Cap O-Ring	2	244126
7	Air Valve Gasket - Buna-N	1	244119
8	Air Valve Screw	4	245578
9	Center Block	1	272344
<b>10</b>	<b>Glyd Ring</b>	<b>7</b>	<b>244133</b>
11	Check Body	1	244130
12	Nipple 3/4" Close	1	272690
13	Check Ball	1	244131
14	Center Block Gasket	2	244118
15	Shaft	1	244116
16	Piston Outer	2	272337
17	Piston Inner	2	272338
18	Air Chamber	2	272339
19	Liquid Chamber	2	272340
20	Clamp Band (large)	2	245577
21	Large Clamp Band Bolt 5/16"-18 x 2 1/4"	4	245571
22	Large Hex Head Nut 5/16"-18	4	245570
23	Clamp Band (small)	4	245572
24	Small Clamp Band Bolt 1/4"-20 x 1 3/4"	8	245574
25	Small Hex Nut 1/4"-20	8	245573
26	Discharge Manifold	1	245568
27	Inlet Manifold	1	245575
28	Hex Head Cap Screw 1/4"-20 x 3"	3	272341
29	Hex Head Nut 1/4"-20	3	272342
<b>30</b>	<b>Diaphragm</b>	<b>2</b>	<b>244114</b>
<b>31</b>	<b>Valve Ball</b>	<b>4</b>	<b>244110</b>
<b>32</b>	<b>Valve Seat</b>	<b>4</b>	<b>244112</b>

All bold face items are primary wear parts.

<sup>1</sup>Air Valve Assembly includes items 2-6.

Model 84813 is aluminum wetted path with Buna-N elastomers.



## LIMITED WARRANTY

Lincoln warrants that lubrication equipment, materials dispensing equipment and other related equipment manufactured by it will be free from defects in material and workmanship during the one (1) year following the date of purchase. If equipment proves to be defective during this warranty period, it will be repaired or replaced without charge, provided that factory examination indicates the equipment to be defective. To obtain repair or replacement, it must be shipped, transportation charges prepaid, with proof of date of purchase to a Lincoln authorized Warranty and Service Center, within the one (1) year following the date of purchase.

This warranty is extended to the original retail purchaser only. This warranty does not apply to equipment damaged from accident, overload, abuse, misuse, negligence, faulty installation or abrasive or corrosive materials, or to equipment repaired or altered by anyone not authorized by Lincoln to repair or alter the equipment. This warranty applies only to equipment installed and operated according to the recommendations of Lincoln or its authorized field personnel. No other express warranty applies to lubrication equipment, materials dispensing equipment, and other related equipment manufactured by Lincoln.

ANY IMPLIED WARRANTIES applicable to lubrication equipment, materials dispensing equipment, and other related equipment manufactured by Lincoln INCLUDING THE WARRANTIES OF MERCHANTABILITY AND FITNESS FOR A PARTICULAR PURPOSE, WILL LAST ONLY FOR ONE (1) YEAR FROM THE DATE OF PURCHASE. SOME STATES DO NOT ALLOW LIMITATIONS ON HOW LONG AN IMPLIED WARRANTY LASTS, SO THE ABOVE LIMITATION MAY NOT APPLY TO YOU.

In no event shall Lincoln be liable for incidental or consequential damages. The liability of Lincoln on any claim for loss or damage arising out of the sale, resale, or use of lubrication equipment, materials dispensing equipment, and other related equipment shall in no event exceed the purchase price. SOME STATES DO NOT ALLOW THE EXCLUSION OR LIMITATION OF INCIDENTAL OR CONSEQUENTIAL DAMAGES, SO THE ABOVE LIMITATION OR EXCLUSION MAY NOT APPLY TO YOU.

THIS WARRANTY GIVES YOU SPECIFIC LEGAL RIGHTS AND YOU MAY ALSO HAVE OTHER RIGHTS WHICH VARY FROM STATE TO STATE.



**One Lincoln Way  
St. Louis, Missouri 63120-1578  
[www.lincolnindustrial.com](http://www.lincolnindustrial.com)**

Your local authorized distributor: